

MITSUBISHI <ANALOG ASSP>  
**M5T494P, FP, GP**

**SWITCHING REGULATOR CONTROL**

**DESCRIPTION**

The M5T494 is a monolithic IC designed for a pulse-width-modulation control circuit.

It contains all functions necessary to control single-ended or push-pull switching power supplies. It employs an on-chip 5-volt regulator, two error amplifiers, an adjustable oscillator, a dead-time control comparator, a pulse-steering flip-flop, output-control circuitry and an undervoltage-lockout (UVLO) function.

The UVLO prevents irregular operation at the IC outputs when the IC supply voltage is excessively low.

**FEATURES**

- Undervoltage lockout (inhibits output for low  $V_{CC}$ )
- Built-in 5-volt reference regulator  
 . . . . . (Reference voltage  $5V \pm 5\%$ )
- Output control selectable for single-ended or push-pull operation.
- Uncommitted outputs for 200-mA sink or source.

**APPLICATION**

Switching voltage regulators, Step-up step-down regulators, Voltage inversion regulators.

**RECOMMENDED OPERATING CONDITIONS**

Supply voltage range . . . . . 7 ~ 40V  
 Pin 3 sink current . . . . . Less than 0.3mA  
 Timing capacitor,  $C_T$  . . . . . 470pF ~ 3.3 $\mu$ F  
 Timing resistor,  $R_T$  . . . . . 1.8 ~ 500k $\Omega$   
 Oscillator frequency . . . . . Lower than 300kHz

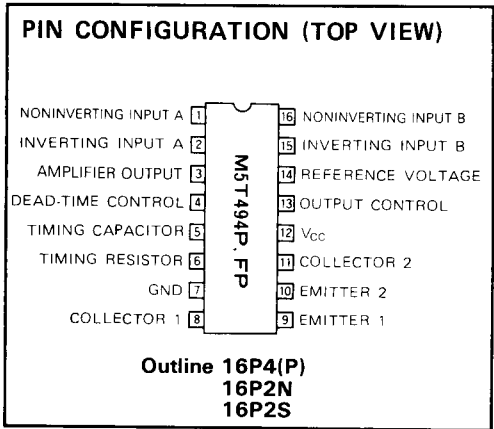

**BLOCK DIAGRAM**

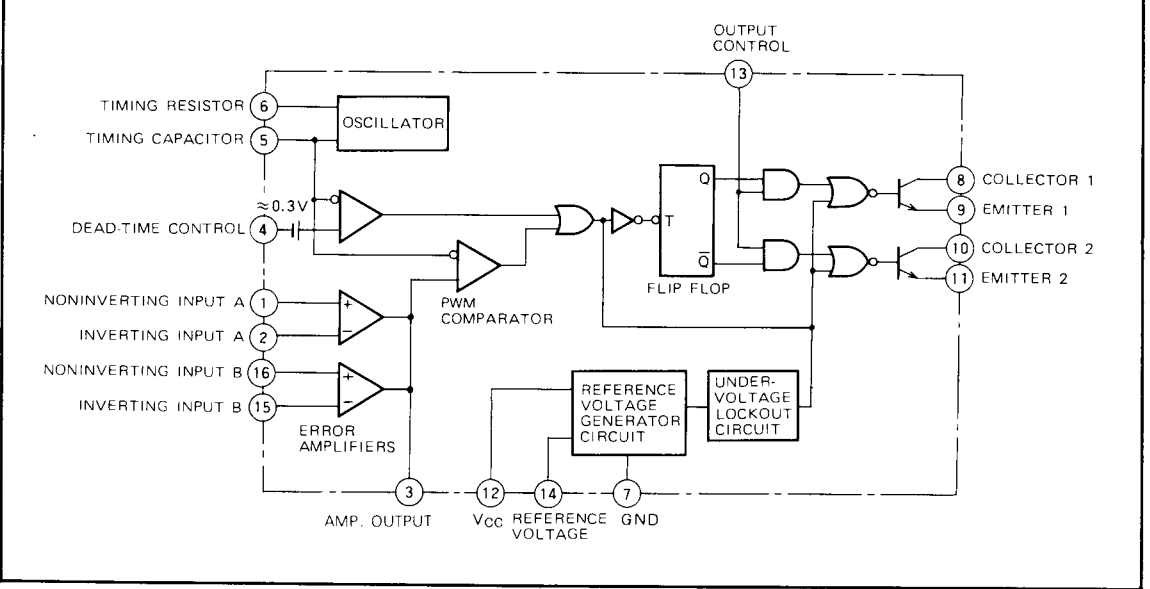

**SWITCHING REGULATOR CONTROL**

**ABSOLUTE MAXIMUM RATINGS** ( $T_a = 25^\circ\text{C}$ , unless otherwise noted)

Symbol	Parameter	Conditions	Limits	Unit
$V_{CC}$	Supply voltage		41	V
$V_{ICM}$	common input voltage		$-0.3 \sim V_{CC}$	V
$V_{ID}$	Differential input voltage		$V_{CC}$	V
$V_O$	Output voltage		41	V
$I_O$	Output current		200	mA
$V_{I3}$	Input voltage		$-0.3 \sim V_{I3} + 0.3$	V
$P_d$	Power dissipation		1000(P)/800(FP)/550(GP)	mW
$K_\theta$	Thermal derating	$T_a \geq 25^\circ\text{C}$	8(P)/6.4(FP)/4.4(GP)	mW/°C
$T_{opr}$	Operating temperature		$-20 \sim +85$	°C
$T_{stg}$	Storage temperature		$-40 \sim +125$	°C

**ELECTRICAL CHARACTERISTICS** ( $V_{CC} = 15\text{V}$ ,  $f_{osc} = 40\text{kHz}$ ,  $T_a = -20 \sim +70^\circ\text{C}$ , unless otherwise noted)

Symbol	Block	Parameter	Test conditions	Limits			Unit
				Min	Typ	Max	
$V_{ref}$	REFERENCE	Output voltage	$I_{ref} = -1\text{mA}$ , $T_j = 25^\circ\text{C}$	4.75	5	5.25	V
$\Delta V_{refIN}$		Input regulation	$V_{CC} = 7 \sim 40\text{V}$ , $I_{ref} = -1\text{mA}$ , $T_j = 25^\circ\text{C}$		1	10	mV
$\Delta V_{refL}$		Load regulation	$I_{ref} = -1 \sim -10\text{mA}$ , $T_j = 25^\circ\text{C}$		2	20	mV
$\Delta V_{ref}/\Delta T_a$		Temperature coefficient output voltage	$T_a = -20 + 85^\circ\text{C}$ , $I_{ref} = -1\text{mA}$		0.01	0.03	%/°C
$I_s$	OSCILLATOR	Short circuit current	$V_{ref} = 0$	-50	-30	-15	mA
$f_{osc}$		Frequency	$C_T = 4700\text{pF}$ , $R_T = 6.2\text{k}\Omega$	37	41	45	kHz
$\Delta f/f_s$		Standard deviation of frequency	$V_{CC} = 7 \sim 40\text{V}$ , $T_a = 25^\circ\text{C}$ , $C_T$ , $R_T$		10		%
$\Delta f/f_{IN}$		Frequency change with voltage	$V_{CC} = 7 \sim 40\text{V}$ , $T_a = 25^\circ\text{C}$ , $C_T = 4700\text{pF}$ , $R_T = 6.2\text{k}\Omega$		0.5	1.5	%
$\Delta f/f_{T_a}$	Frequency change with temperature	$T_a = 0 \sim 70^\circ\text{C}$ , $C_T = 4700\text{pF}$ , $R_T = 6.2\text{k}\Omega$		1	2	%	
$I_{I3}$	DEAD-TIME CONTROL	Input bias current	$V_{I3} = 0 \sim 5.25\text{V}$	-7	-0.7		$\mu\text{A}$
$D_{MAX}$		Maximum duty cycle (each output)	$V_{I3} = 0\text{V}$	42	45	48	%
$V_{I3TH1}$		Input threshold voltage 1	Zero duty cycle (each output)		2.45	2.80	V
$V_{I3TH2}$		Input threshold voltage 2	Maximum duty cycle (each output)		0		V
$V_{AMPIO}$	ERROR AMPLIFIERS	Input offset voltage	$V_{(3)} = 2.5\text{V}$		1	7	mV
$I_{AMPIO}$		Input offset current	$V_{(3)} = 2.5\text{V}$		5	200	nA
$I_{AMPIB}$		Input bias current	$V_{(3)} = 2.5\text{V}$	-700	-100		nA
$V_{AMPICM}$		Common input voltage range	$V_{CC} = 7 \sim 40\text{V}$	-0.3		$V_{CC} - 2$	V
$A_V$		Open loop voltage gain	$V_{(3)} = 0.5 \sim 3.5\text{V}$ , $T_a = 25^\circ\text{C}$	70	110		dB
$f_T$		Gain bandwidth product	$T_a = 25^\circ\text{C}$	500	900		kHz
$CMRR$		Common mode rejection ratio	$V_{CC} = 40\text{V}$ , $T_a = 25^\circ\text{C}$	65	85		dB
$I_{I3SINK}$		Output sink current	$V_{(3)} = 0.7\text{V}$	0.3	0.7		mA
$I_{I3SOURCE}$		Output source current	$V_{(3)} = 3.5\text{V}$		-10	-2	mA
$V_{I3RANGE}$		Output voltage range	"L" level "H" level	$I_{(3)} = 0$		0.1 0.3	V
				4.2	4.9	V	
$V_{I3TH}$	PWM COMPARATOR	Input threshold voltage	Zero duty cycle (each output)		3.4	3.8	V
$I_{I3SINK}$		Input sink current	$V_{(3)} = 0.7\text{V}$	0.3	0.7		mA

**SWITCHING REGULATOR CONTROL**

**ELECTRICAL CHARACTERISTICS**

Symbol	Section	Parameter	Test conditions	Limits			Unit
				Min	Typ	Max	
$I_{CL}$	OUTPUT	Collector leak current	$V_{CE} = 40V, V_{CC} = 40V$ (Common-emitter)		0.01	100	$\mu A$
$I_{EL}$		Emitter leak current	$V_{CC} = V_C = 40V, V_E = 0$ (Emitter follower)	-100	-0.01		$\mu A$
$V_{CESAT}$		Output saturation voltage (Common-emitter)	$I_C = 200mA, V_E = 0$		0.95	1.3	V
$V_{CEON}$		Output saturation voltage (Emitter follower)	$I_E = -200mA, V_C = 15V$		1.6	2.5	V
$t_{r1}$		Output-voltage rise time	$V_{CC} = 15V, R_L = 150\Omega, I_C = 100mA,$ $T_a = 25^\circ C$ (Common-emitter)		80	200	ns
$t_{f1}$		Output-voltage fall time			30	100	ns
$t_{r2}$		Output-voltage rise time	$V_{CC} = V_C = 15V, R_L = 150\Omega, I_E =$ $-100mA, T_a = 25^\circ C$ (Emitter follower)		200	400	ns
$t_{f2}$		Output-voltage fall time			30	100	ns
$I_{i3}$		Output-control input current	$V_{i3} = V_{ref}$		270	550	1000
$V_{CCLO}$	UNDER VOLTAGE LOCK-OUT	Lockout voltage	Supply voltage at output cut-off	3.8	5	5.7	V
$\Delta V_{CCLO}$		Hysteresis		100	200	380	mV
$I_{CCSB}$	CIRCUIT CURRENT	Standby supply current	$V_{CC} = 15V$ All other inputs and outputs open		6.7	11.5	mA
$I_{CCBI}$		Average bias current	$V_{i4} = 2V,$		7.3	13	mA

**TEST CIRCUIT**

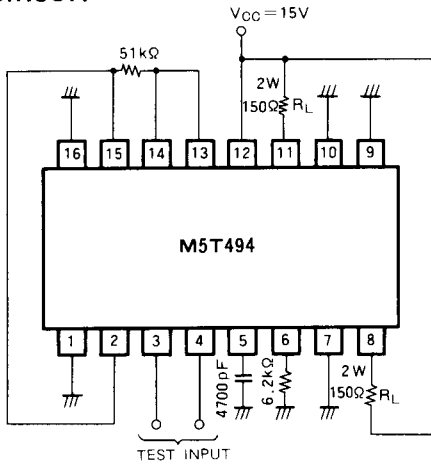

Note: To obtain output voltage from the emitter follower, connect pins ⑧ and ⑩ to  $V_{CC}$ , and connect each of pins ⑨ and ⑪ to ground through resistor  $R_L$ .

**THERMAL DERATING (MAXIMUM RATING)**

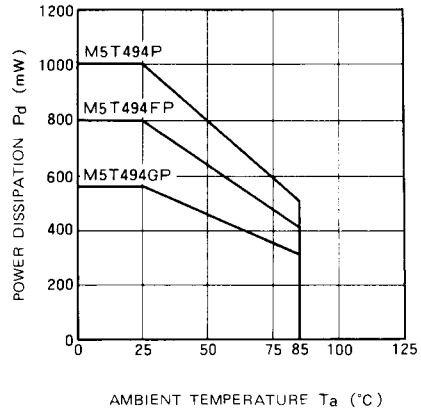

**UNDERVOLTAGE LOCKOUT CHARACTERISTICS**

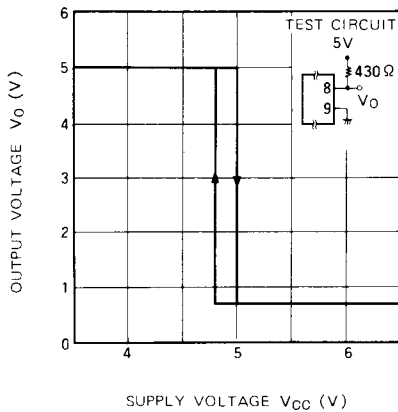

**LOCKOUT VOLTAGE VS AMBIENT TEMPERATURE**

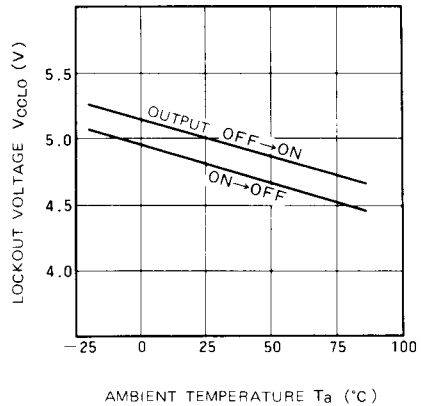

**SWITCHING REGULATOR CONTROL**

**REFERENCE VOLTAGE VS SUPPLY VOLTAGE**

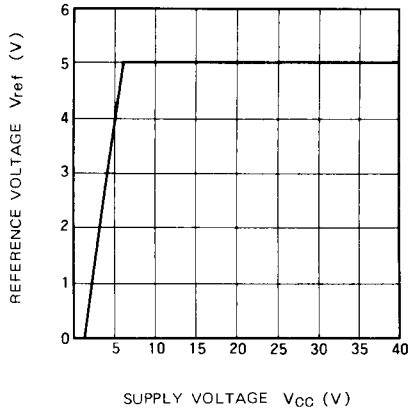

**OSCILLATOR FREQUENCY VS TIMING RESISTANCE**

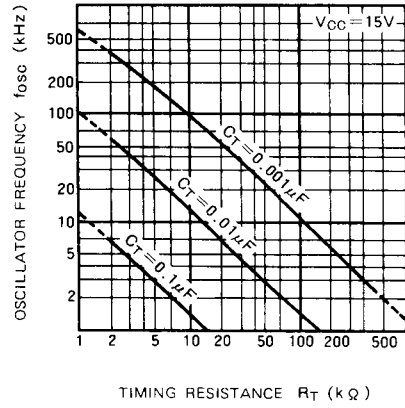

**OSCILLATOR FREQUENCY CHANGE VS AMBIENT TEMPERATURE**

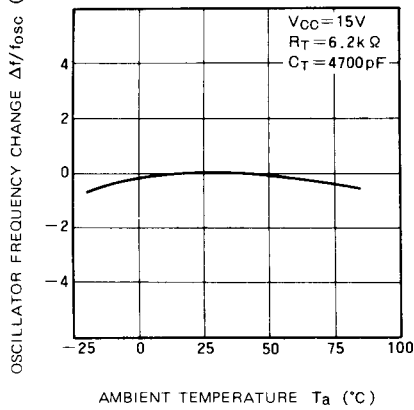

**REFERENCE VOLTAGE CHANGE VS AMBIENT TEMPERATURE**

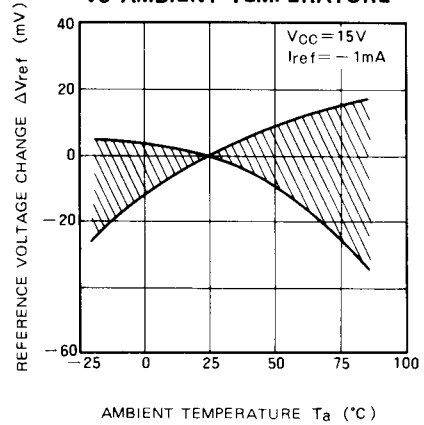

**OUTPUT DUTY CYCLE VS DEAD-TIME CONTROL INPUT VOLTAGE**

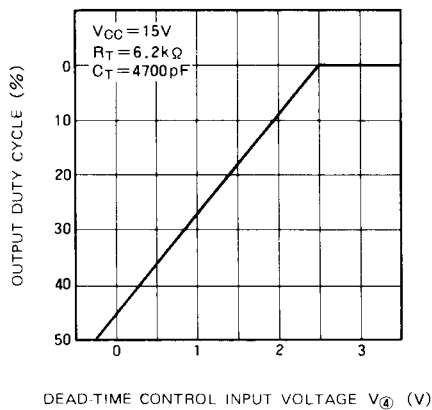

**ERROR AMP OPEN LOOP VOLTAGE GAIN VS FREQUENCY**

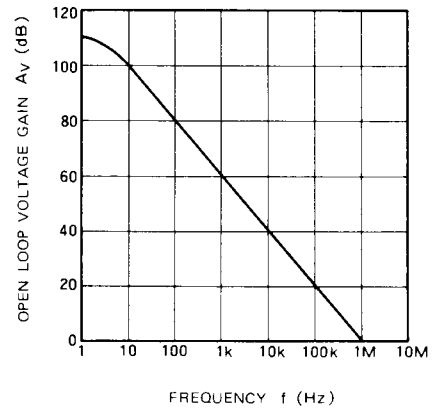

**SWITCHING REGULATOR CONTROL**

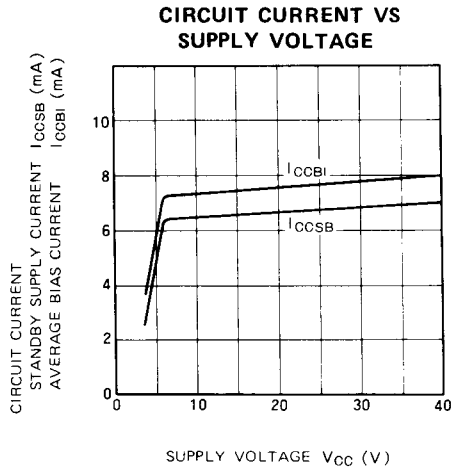
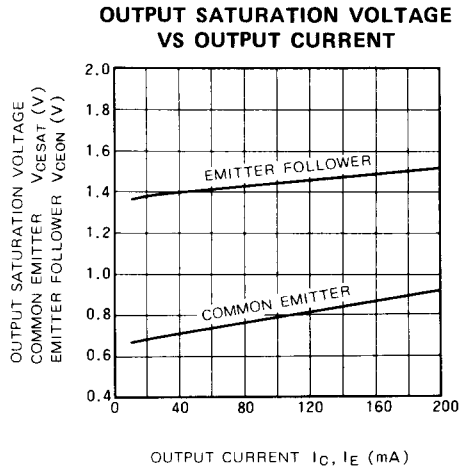

**VOLTAGE WAVEFORMS**

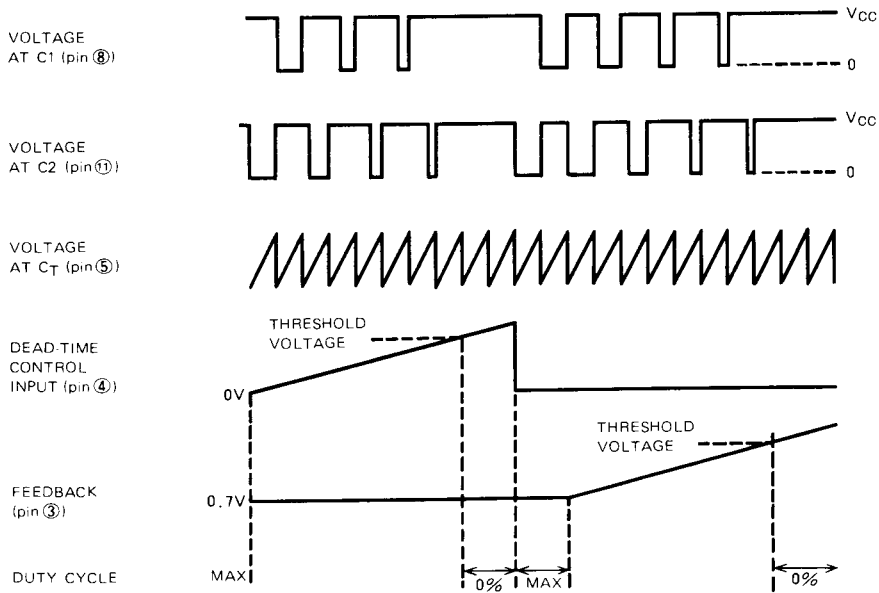

**FUNCTION TABLE**

OUTPUT CONTROL (pin 13)	OUTPUT FUNCTION
$V_{ref}$	Push-pull operation
GND	Single-ended or parallel operation